



www.truckohio.com



\$69.95



\$49.95



Tubular Cargo Rack

- Supports a 500 pound load
- Lightweight, tubular design
- Provides maximum durability
- Large available cargo space measuring 20"x45"
- Mounts on any 2" hitch receiver
- Easy installation, no drilling required
- Black powder coated steel construction

Dual Hood Scoops

- Performance Look (Non-Functional)
- Paintable A.B.S. Plastic
- Peel-N-Stick Installation
- Sold in Pairs

OHIO LIGHT TRUCK PARTS STOCKS MORE CUSTOM FIT HITCHES THAN ANYONE AROUND

Class III, IV & V

Prices Start at \$119.95

Many Models Install Without Drilling



Ohio Light Truck Parts

**Mon. • Wed. • Fri. 8-5
Tues. & Thurs. 8-6
Saturday 8-12**

7643 Fort Laurens Rd. Strasburg, OH • 330-878-6587

Helper Springs

Increases spring capacity by up to 3500 lbs. Simple bolt-on installation, with no drilling necessary. All the necessary hardware is included in the purchase. This product is at the top of the line in heavy duty load management and towing control for pickup, vans, and motor homes. High Quality, precision arched spring steel is used. The springs are fully adjustable with progressive spring rates for the best quality ride possible whether empty or fully loaded. Millions of in-use service miles from thousands of satisfied customers have made these the springs to have! So pile on the firewood or hook up the trailer to a new ride!

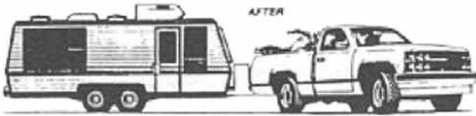
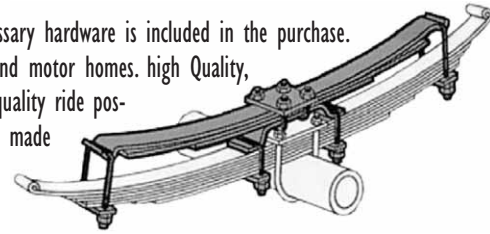

1000 lb. Capacity from **\$99.95 Pair**

1500 lb. Capacity for mid size and mini trucks from **\$159.95 Pair**

2500 lb. Capacity for full sized vehicles from **\$259.95 Pair**

3500 lb. Capacity for 3/4 and 1 ton vehicles from **\$309.95**

Firestone Air Ride

Firestone's complete line of air helper springs are installed between the vehicle's frame and suspension. They supplement the vehicle's stock suspension and can be adjusted as needed for changing load, towing or on/off road conditions. The helper springs can be easily inflated or deflated (5-100 psi) to balance and level the vehicle providing smooth and safe travel. On board compressors also available.

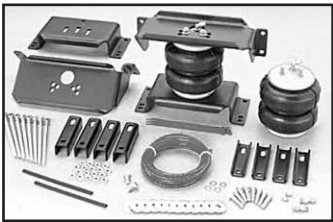

Sport-Rite® Basic Kit



Ride-Rite® Basic Kit



Coil-Rite® Basic Kit

EXPERT INSTALLATION AVAILABLE

Timbren Suspension

What is Timbren?

TIMBREN
RIDE QUALITY PRODUCTS

Timbren is a suspension product which enhances a vehicle's empty ride quality, while providing protection against overloading, road shock, bottoming out, sway, and broken springs. Timbren also prevents front end nose diving, providing a smooth, level ride even with heavy loads.

Timbren is currently in use on thousands of vehicles throughout the world. Maintain a level and worry free ride by installing Timbren Hollow Rubber spring kits on your van or truck.

Without Timbren

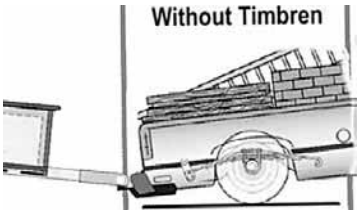

With Timbren

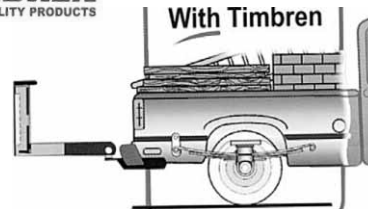

Steering Stabilizers Shock Absorbers

CALL FOR PRICING



CALL FOR PRICING



\$39.95



\$39.95



Single Steering Stabilizers

Tuff Country EZ-Ride's Dual SX5000 steering stabilizers are designed for the aggressive off-roader with oversized tires looking to improve handling characteristics and reduce steering shimmy. Dual stabilizers are most effective when used with 35" or larger tires. Shock boots included.

Dual Steering Stabilizers

Tuff Country EZ-Ride's Dual SX5000 steering stabilizers are designed to improve handling characteristics and reduce steering shimmy. Single stabilizers are most effective when used with 33" or smaller tires. Includes shock boots.

Tuff Country EZ-Ride's SX6000

Cellular Gas shock absorbers are recommended for mid-size & mini applications. The multi stage valving provides smooth controlled ride on and off-road. Shock boot included. Lifetime limited warranty.

Tuff Country EZ-Ride's SX8000

Nitro Gas shock absorbers are recommended for all full size applications. The nitrogen gas pressure reduce fade and gives quicker shock response. Shock boot included. Lifetime limited warranty.

Cab Lights

MOST light trucks do not come with cab roof running lights as do dualie's and big rigs. These cab roof lights give oncoming traffic a better visual fix for additional safety. Pacer Hi-Five® kits come complete with lights, wire harness and instructions for easy installation. All kits meet S.A.E. specifications.



\$29⁹⁵ to \$69⁹⁵ per set

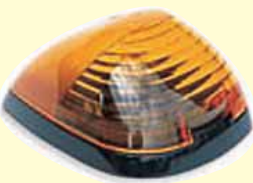

Model

Chevy Style

Dodge Style

Ford Style

Late Chevy Style

Aftermarket Body Parts

Ohio Light Truck Parts has large selection of Aftermarket Body Parts Available for Domestic and Foreign Trucks and Sports Utility Vehicle at Affordable Prices.



Hoods



Fenders



Headlight Assemblies

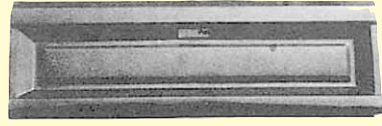

Tailgates...and much More!

The Ultimate Sliding Rack System

TracRac Slides

- Reposition or remove racks in seconds
- Slide Toolbox to Tailgate

TracRac is Built Tough

- Rugged Aluminum-no rust or corrosion
- Carries 1,000lbs. but only weights only 77lbs.

TracRac's Easy-to-Install

- Installs without drilling or bolting, on trucks with stake pockets.

TracRac's Versatile

- Carries Lumber, ladders, building materials, canoes and kayaks.



Cargo Holder

Trap loose cargo in the bed, or flip for a rear window guard! Just one of the many advantages of choosing TracRac

Miscellaneous

Leveling Kits

Make	Model	Year	Lift	System	w/o Shocks
Dodge	Ram 1500 4WD	94-01	2"	Leveling Kit	\$159
Dodge	Ram 2500/3500 4WD	94-04	2"	Leveling Kit	\$159
Ford	F150 4WD	2004	2"	Leveling Kit	\$139
Ford	F250/F350 4WD	2005	2"	Leveling Kit	\$169
Ford	F250/F350 4WD	99-04	2.5"	Leveling Kit	\$339
Nissan	Titan 2WD/4WD	2004	2"	Leveling Kit	\$149
Toyota	Tundra 4WD/2WD	99-04	2"	Leveling Kit	\$159
Toyota	Tacoma 4WD/2WD	95-04	2"	Leveling Kit	\$159



Pitman and steering arms are recommended for most vehicles lifted 4' and above. Some problems these arms will help correct are bump steer and a shortened turning.



Most blocks are now available in 2.5" or 3" widths. Non-tapered 4" & 5.5" are also available.

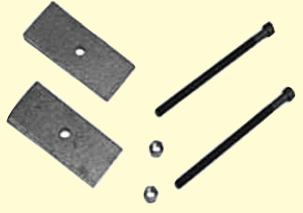

Degree shims can help to correct drive line vibration problems associated with some lift vehicles.



Add-a-leaves are an economical method of lifting vehicles that have leaf springs. Center pins are included with all kits.



When replacing leaf springs don't forget to also replace your U-bolts

STAINLESS STEEL FUEL DOOR COVERS



\$19.95

- Made of T-304 Stainless Steel
- Easy Peel-N-Stick Installation
- Covers Factory Side Fuel Door
- Polished or Brushed Finishes

BILLET FUEL DOOR

\$49.95



GRILLE EMBLEM



From \$24.95 to \$34.95

Replace your factory Grille Emblem with a beautiful Billet Aluminum Emblem. They provide a quick & easy way to give your truck a custom look.

EMBLEM COVERS

\$14.95



- Polished Stainless Steel Construction

BILLET GRILLES

Bolt-On Billet Grilles

- Easy to Install, Mounts Easily over Existing Stock Grille
- Machined From T-6 Billet Aluminum
- High Polish Finish

Prices Starting at \$99.95



QUICK BOLT-ON APPLICATION!

STAINLESS STEEL TRIBAL FLAME TRIM

- Mirror Polished T-304 Stainless Steel
- Easy to Install with Peel-N-Stick Automotive Tape



Universal Tailgate Handle Flame Kits

- TT-001 Large Includes 2 Pieces
- TT-002 Small Includes 2 Pieces
- Designed to fit 97-03 F-Series



Ford Oval Flame Trim

- TT-201 Large 6" | Piece Included
- TT-202 Small 4" | Piece Included
- TT-203 Ford Oval Flame Trim For 04-up Ford F-150



Universal Flame Emblem

- TT-051 Large | Piece Included
- TT-052 Small | Piece Included

From \$17.95 to \$24.95

WEIGHT DISTRIBUTION HITCHES

Weight Distribution Hitches evenly distribute weight over the entire length of tow vehicle and trailer, resulting in a more level ride with more control and stability, better braking, less strain on vehicle and increased towing capacity.

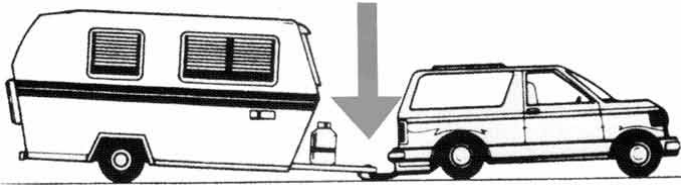

Without Weight Distribution

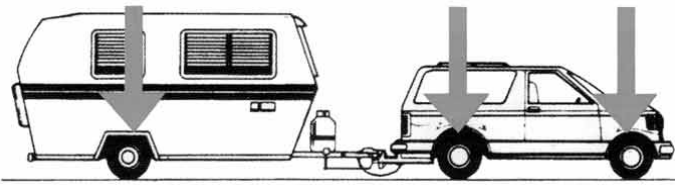

With Weight Distribution

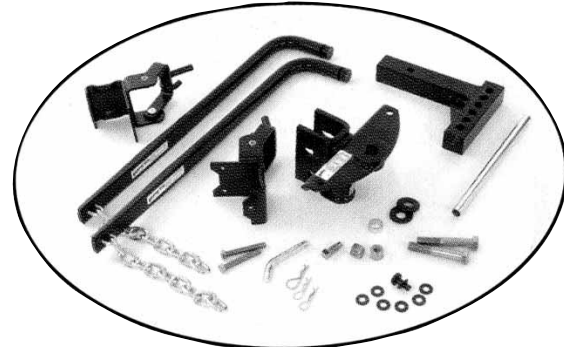

\$249.95

• Balls not included

Rated up to 10,000 lbs.

**Limited
Lifetime
Warranty
Against Rust
& Corrosion**

\$449⁰⁰



Grille Bars

**SPECIAL on all Ohio Light Truck Parts Brand
Stainless Steel Grille Guards**

FREE INSTALLATION TILL JUNE 1ST, 2007

7643 Fort Laurens Rd. Strasburg, Ohio 44680

BALL MOUNT MEASUREMENTS

LENGTH

Distance From the Center of the Ball Hole to the Center of the Pin Hole

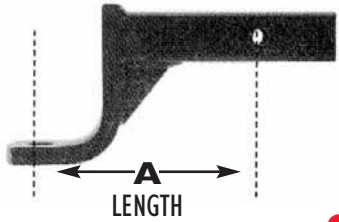

RISE

Distance From the Top of the Shank to the Top of the Ball Platform

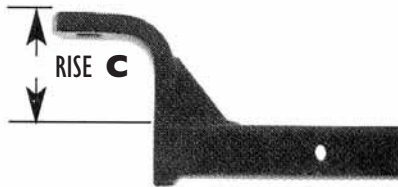

DROP

Distance From the top of the Shank to the Top of the Ball Platform

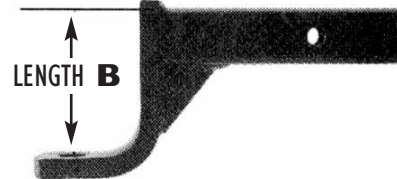

CLASS III BALL MOUNTS

Drop	Rise	Length A	Price
2"	3/4"	8"	\$15.95
2"	3/4"	10"	\$19.95
4"	2-1/2"	8-1/2"	\$19.95
4"	2-1/2"	10-1/2"	\$21.95
6"	4-1/2"	9"	\$22.95
8"	6-1/2"	10"	\$24.95
10"	8-1/2"	10"	\$39.95

2" RECEIVER TUBE

- 6" Long \$15.95
- 12" Long \$19.95



80812

ONE PIECE PINTLE HOOKS/COMBINATION

- 5 ton Pintle Hook \$94.95
- 2" Ball & Pintle Combo 6 ton \$119.95
- 2-5/16" Ball & Pintle Combo 6 ton \$119.95



PINTLE HOOKS/COMBINATION

- New and improved pintle offering

- | | |
|--|---|
| 5 ton Pintle Hook \$44.95 | 2-5/16" Ball & Pintle Combo 8 ton \$74.95 |
| 10 ton Pintle Hook \$54.95 | Fixed Pintle Eye \$54.95 |
| 2" Ball & Pintle Combo 8 ton \$69.95 | Adjustable Pintle Eye \$49.95 |

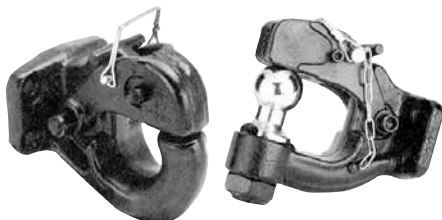

OHIO LIGHT TRUCK PARTS SELLS & INSTALLS 5TH WHEEL & GOOSENECK HITCHES

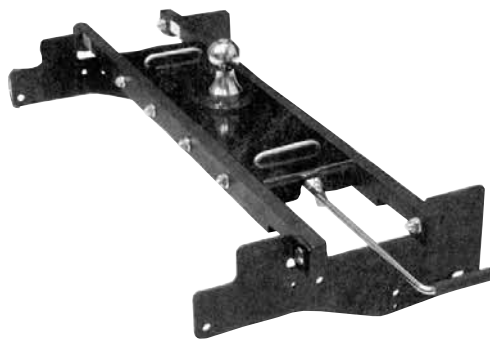
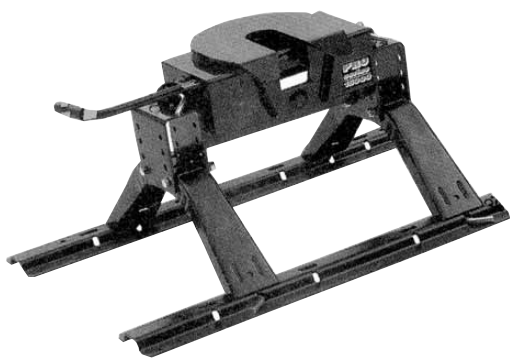

EXPERT INSTALLATION AVAILABLE

Class III, IV & V

Prices Start at \$119.95

Many Models Install Without Drilling

**OHIO LIGHT TRUCK PARTS
STOCKS MORE CUSTOM
FIT HITCHES THAN
ANYONE AROUND**

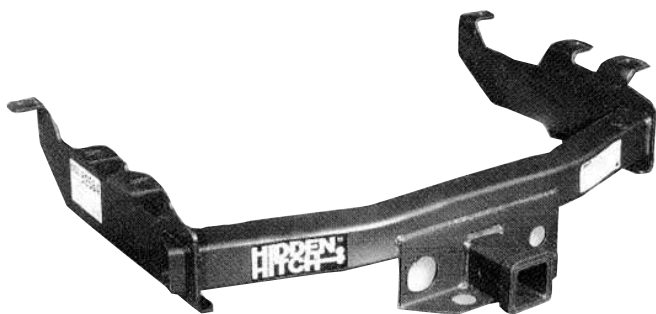

Hide-A-Goose Hitches

- Rated at 15,000 lbs. Tested to 30,000 lbs. G.T.W. 7500 lbs. vertical load.
- Only requires a 4" hole in your truck bed for installation.
- Ball is stored upside down in hitch when not used.
- Heavy Duty handle uses positive locking to engage the ball.
- Hitch uses maintenance free nylon bushings.
- Hitch head is E-Coated for superior corrosion resistance.
- Comes with hitch head, 2 5/16" ball, and safety chain brackets.



\$399.95

ADJUSTABLE PINTLE MOUNTS



- For use with receivers with 2" ID. openings
- Solid steel 2"x2" shank
- 1/2" plate
- CURT's exclusive EverGloss Black powder coat finish

GTW	Holes	Description	Price
10,000	4 pair	7" plate, 8-1/2" shank, Pintle mount	\$35.95
10,000	7 pair	13" plate, 12-1/2" shank, Pintle mount	\$54.95
N/A	N/A	Bolt Kit for pintle mounts includes: <ul style="list-style-type: none"> • 4 Grd. 8 Hex Head Bolts (1/2"-13) • 4 Grd. 8 Hex Nuts (1/2"-13) • 4 Grd. 8 Lock Washers (1/2") 	

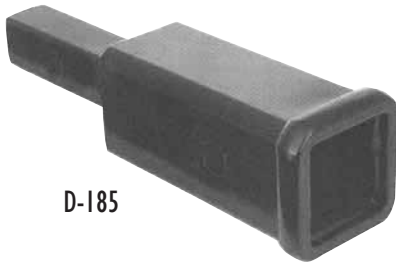

D-185

RECEIVER ADAPTERS

- One piece unit used for converting the size of the receiving tube to either 1-1/4" or 2"

Capacity	Description	Adapts From	Adapts to	Extends	Price
3,500 lbs.	Receiver Adapter	2"	1-1/4"	7"	\$19.95
3,500 lbs.	Receiver Adapter	1-1/4"	2"	6"	\$24.95



80306

HITCH BOX EXTENSIONS

- Ideal for slide-out campers with extended overhangs
- Designed to extend the receiver opening 14", 18", 24", 34", 41" or 48"
- 2" opening for use with standard ball mounts and hitch mounted accessories
- For use with receivers only

Description	Length	WC (lbs)	Price
Hitch Box Extension	18"	3,500	\$39.95

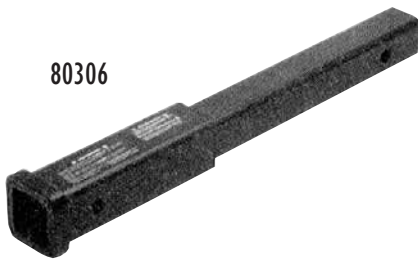

HITCH BOXES

- Bolts to the rear of the pick-up step bumper
- Offers lower hitch point to provide level trailer towing

Description	GTW/TW	Price
2"x2" ID Receiver hitch box w/spacer kit	5,000/500	\$39.95

- V-5 Rated and Tested
- Grade 5 Mounting Hardware
- CURT's EVERGLOSS Black Powder Coat Finish
- Spacer Bushing Included
- Maximum GTW 5,000/TW 500
- Attractive Display Packaging
- Pro-S Design Seamless Formed Collar
- 3/8" Steel Plate
- Safety Chain Hookups
- Robotic Welded

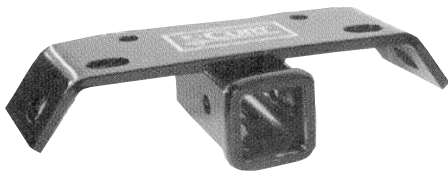



\$44.95

3 BALL SOLID SHANK

• 1-7/8", 2" & 2-5/16"

Description	Shank Length	Ball Size	Capacity GTW/TW
3 Ball-Ball Mount	8"	1-7/8"	2,000/200
	8"	2"	6,000/600
	6-3/4"	2-5/16"	10,000/1,000

ONE PIECE FORGED BALL MOUNTS

- These units are used when heavy duty towing is required.
- Rates up to 12,000lb
- Requires a 1-1/4" Shanked Hitch Ball



Drop	Rise	Price
2"	3/4"	\$29.95
4"	2"	\$33.95
6"	4"	\$36.95

NEW ADJUSTABLE BALL MOUNT

- Easily adjusts from 2" to 7-1/2" drop and up to 6" rise
- Eliminates the need for multiple ball mounts
- 5,000lb Rating

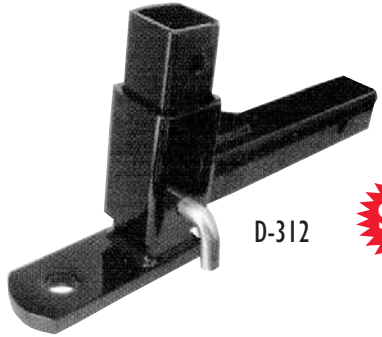

\$49.95

STAINLESS STEEL HITCH BALL MOUNTS & HITCH BALLS



2" Drop \$34.95
3" Drop \$35.95

- Fits 2" Opening
- Solid T-304 Stainless Steel Construction
- Polished Mirror Finish
- Up to 6000lb. GTW and 600lb.
- Lifetime Warranty



\$24.95

CR-761
• 7000 lbs. GTW
• 2" Dia. Ball



\$29.95

CR-762
• Patented Golf Ball Design!
• 7000 lbs. GTW
• 2" Dia. Ball

- Solid T-304 Stainless Steel Construction
- Polished Mirror Finish
- 2 1/8" Stud Length and 1" Stud Dia.
- Lifetime Warranty

HITCH BALLS

How to Select the Correct Hitch Ball.

- Select the correct ball for the coupler on your trailer.
- The ball diameter required is stamped into the coupler handle or body
- Ensure the trailer ball shank fits the thickness and diameter of your drawbar, ball mount or step bumper

Bulk Hitch Balls

Ball Dia. A	Shank Dia. B	Shank Length C	GTW GVWR Rating	Price
1-7/8"	3/4"	2-5/16"	2,000	\$8.95
1-7/8"	1"	2-1/8"	2,000	\$7.95
2"	3/4"	2-5/16"	3,000	\$8.95
2"	1"	2-1/8"	6,000	\$7.95
2"	1-1/4"	2-1/4"	8,000	\$14.95
2-5/16"	1"	2-1/8"	6,000	\$10.95
2-5/16"	1-1/4"	2-1/4"	10,000	\$14.95

SWITCH BALL

Designed for Safety and Top Performance

- No Tools required.
- No attachment pin to remove
- More time for recreation, less time in preparation.

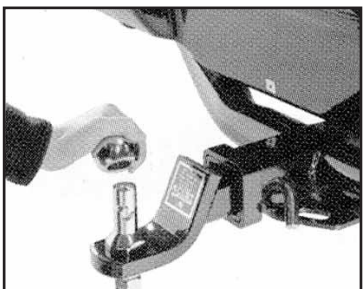

SLIDE ON.

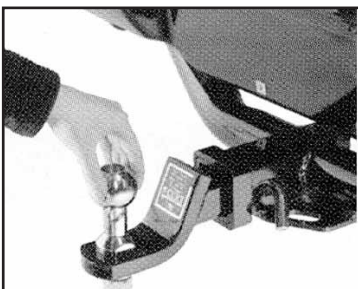

TWIST.

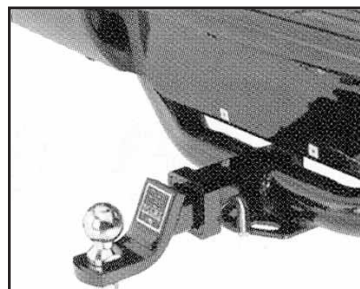

READY TO TOW!

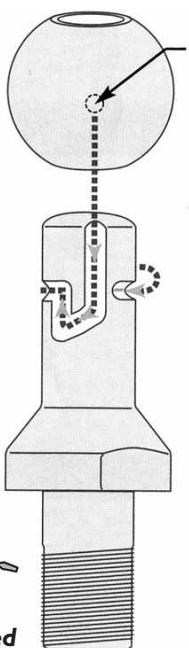

Guide pin inside of ball slides easily along shaft groove to lock ball securely in place.

**SLIDE
DOWN
OVER
AND UP
THEN
TWIST**



No Pins



**No Tools or
Coins Required**

- Constructed from premium grade steel with nickel-chrome plating for long life.
- Switch~Balls™ is guaranteed for life against defects in manufacturing. An Independent laboratory extensively tested the shank and ball to insure quality and durability.
- Switch~Ball™ complies with National Standard SAE-J684 and V-5 Regulations for conversion ball sets.
- The exclusive ;j; Grove design ensures with the ball installed on the shank and engaged by a coupler, the hitching system is secure and has been proven safe through independent testing.
- Designed so the weight bearing capacity is resting on the shank taking the stress away from the ball freeing the coupler from friction and binding, providing smoother and safer towing.
- US Patent #5,169,168 Canadian Paten #1,325,445

Replacement Parts Available

Description	Capacity	Price
1" shank with 1-7/8" & 2" balls	6,000	\$24.95
1" shank with 1-7/8", 2" & 2-5/16" balls	8,000	\$28.95
1" shank with 2" & 2-5/16" balls	8,000	\$24.95

Let Ohio Light Truck Parts help you avoid Deer and other avoidable objects by adding a set of auxiliary lights to your vehicle.



Many Styles are Available Please Stop in Our Store to See Many More Styles and Sizes

INSTALLATION AVAILABLE



\$24.95 Pair

NV-100

- Auxiliary Driving Light
- Black Plastic Housing
- 55 Watts
- 3"x5 1/2"
- Includes wiring Harness
- Available in Clear Driving & Amber Fog



\$19.95 Each

NV-301

- Tractor Light
- Black Plastic Housing
- 55 Watts • 4 1/2"x7"
- Makes an Excellent Backup or Work Light



\$49.95 Pair

NV-200C

- Plastic Housing
- 55 Watt Halogen/PL-H3 Bulb
- Features a Pre-Assembled Wiring Harness



\$69.95 Pair

PL-880B

- Die Cast Aluminum Housing
- 55 Watt Halogen/PL-HE Bulb
- Features a Pre-Assembled Wiring Harness with a Relay
- Also available in a clear Lens with a White Beam (PL-880C)

Increased Visibility

Our Navigator Cyber White series driving lights are designed to enhance the beam from your factory head lamps for increased visibility and distance viewing. They include the necessary hardware and wiring to make installation as simple as possible.



\$89.95 Pair



Fog Light

PL-114C Dodge

- 94-01 Ram without Transmission Cooler, Diesel or Dually
- 55 watt Halogen/PL-H3 Bulb
- Complete Pilot Wiring Harness
- Also Available in a Blue Lens with a yellow Beam (PL-114B)



\$79.95 Pair



Fog Light

PL-119C Dodge

- 97 and up Dakota
- 55 Watt Halogen / PL-H3 Bulb
- Complete Pilot Wiring Harness
- Also Available in a Blue Lens with a Yellow Beam (PL-119B)



\$129.95 Pair



Fog Light

PL-133B Chevrolet

- 99-02 Silverado
- 55 Watt Halogen / PL-H3 Bulb
- Features a pre-Assembled Wiring Harness with a Relay and Remote Transmitter / PL-HARN7
- Also Available in a Clear Lens with a White Beam (PL-133C)



\$89.95 Pair



Fog Light

PL-138C Dodge

- 02-Up Ram
- 55 Watt Halogen / PL-H3 Bulb
- Complete Pilot Wiring Harness
- Also Available in a Blue Lens with a simulated H.I.D. White Beam (PL-138W)

7643 Fort Laurens Rd. Strasburg, Ohio 44680

Telescopic Trailer Tow Mirror

Built-in adjustable spot mirror & fantastic quality glass make this the ultimate mirror even when you're not towing

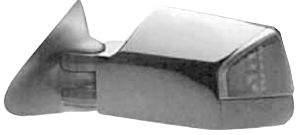

Just slide out to safely see around any legal width trailer.

Louvered 5th-Wheel Tailgate

The only true form-fitted steel 5th wheel tailgate.



\$239 to \$259

Heavy Duty 16 & 20 Gauge Steel Easy center latch Opening Fast Easy Installation
Black Power-Coated Finish Easily Painted to Match Your Truck Improves Backing Visibility



We invite you to compare our tailgate to any other model regardless of price. We believe you'll agree that nothing else comes close.

Hitch Covers

Ohio Light Truck Parts Offers a large selection of custom hitch covers. Be sure to stop in and find the one that complements your ride!



Receiver Hitch Locks and Trailer Locks

Ohio Light Truck Parts also stocks a large assortment of receiver hitch locks and trailer locks. Many are available in stainless steel. Here are just a few.



Replaces 5/8" Sleeve in hitch receiver for rattle-free towing!



Lock your trailers securely with the two handy pieces!



Electronic Brake Controllers

Brake-Force™

\$59.95

Impulse™

- Convenient digital display indicates
- Percentage of power output to trailer
- Short Circuit conditions
- Trailer connection
- Single adjustment wheel makes obtaining optimum setting easy
- Short-proof protection from electronic brake wire shorts
- Operates at any angle, including upside down

\$89.95



- Smart LED light display indicates
- Power to the control
- Level of power to the trailer with a gradual change from green to bright yellow
- Electric brake wire shorts
- Single adjustment when makes obtaining optimum setting easy.
- Short-proof protection from electric brake with shorts
- Operates at any angle, including upside-down.

Electrical Supplies

Ohio Light Truck Parts stocks all the electrical supplies you need to do your trailer. Expert installation is always available.

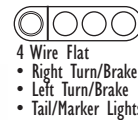

- 4 Pole Round
- Right Turn/Brake
 - Left Turn/Brake
 - Tail/Marker Lights



- 5 Pole Round
- Right Turn/Brake
 - Left Turn/Brake
 - Tail/Marker Lights
 - Electric Brake, Aux or backup

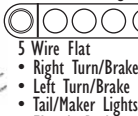

- 6 Pole Round
- Right Turn/Brake
 - Left Turn/Brake
 - Tail/Marker Lights
 - Electric Brake
 - Aux. Power Lead



- 7 Pole Round
- Right Turn/Brake
 - Left Turn/Brake
 - Tail/Marker Lights
 - Electric Brake
 - Aux. Power Lead
 - Backup Lights



\$289⁰⁰

Bull Bars



\$249 to \$279

Nerf Bars



\$449⁰⁰

Grille Bars

Ohio Light Truck Parts purchased a semi load of Nerf Bars, Grille Guards, Bull Bars, Bed Rails & Tiedowns direct from the manufacturer. By cutting out all middle men we will be able to offer these items at a price well below what any one else is able to offer.

PLEASE HURRY AS QUANTITIES AND APPLICATIONS ARE LIMITED

- **Stainless Steel Lifetime Rust Warranty**
- **Experts Installation Available**
- **No Drill Mounting**
- **Awesome Quality Low Price**
- **Stainless Steel Say Goodbye to Rusty Chrome**

DIAMOND PLATE ALUMINUM TOOL BOXES



Starting at \$199

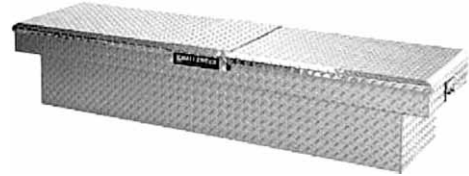

We stock 7 different sizes for a truly custom fit!

- Made 100% of Aluminum
- Will not rust, crack or sag
- Positive stay-open gas springs
- Fully welded construction
- Requires no maintenance
- Full width hinge

TAILLIGHT COVERS

- 30 Design Adds Protective Style and Elegance
- Made From Triple Chrome Plated High Impact ABS Plastic
- Automotive Grade Adhesive Tape Ensures a Strong Adhesion

From \$89.95

MANY OTHER MODELS AVAILABLE

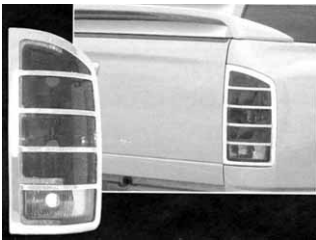

SDL-302

2002-2005 Dodge Ram 1500/2500/3500



SDL-204

2004-2005 Ford F150 (Styleside)

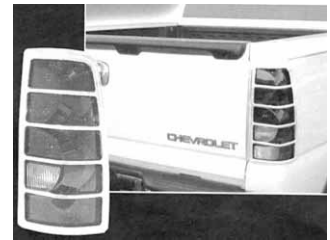

SDL-104

2003-2005 Chevy/GMC Silverado/Sierra (Styleside)

STAINLESS STEEL

DOOR HANDLE COVER KITS & TAILGATE HANDLE TRIM KITS

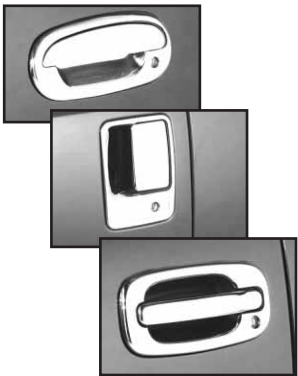

- Made of T-304 Stainless Steel
- Covers Door Handle and Housing
- Easy Peel-N-Stick Installation

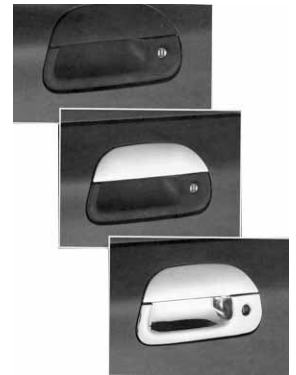

PRICE VARIES BY APPLICATION

ALUMINUM STEPS

From \$49.95 Pair



- Strong, Lightweight, Paintable
- Non-Slip Step Pad
- Polished Die-Cast Aluminum Brackets
- Solid Mount



DUAL HOOD SCOOPS

- Performance Look (Non-Functional)
- Paintable A.B.S. Plastic
- Peel-N-Stick Installation
- Sold in Pairs

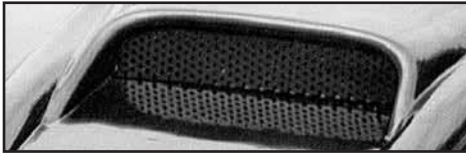

\$49.95

INTEGRATED O.E. LOOK TAILGATE LOCK

These Tailgate Lock Have Been Designed to Give Your Truck an O.E. Look While Securing the Tailgate To Help Prevent Theft. These Patented Tailgate Locks Are Perfect For Truck Caps and Tonneau Covers. Available for Chevy, GMC, Ford, and Dodge Applications.

- LH-002 88-98 GM Silverado/Sierra 1500/2500/3500
- LH-003 99-06 GM Silverado/Sierra 1500/2500/3500
- LH-004 87-96 Ford F-Series
- LH-005 97-04 Dodge Dakota
- LH-006 94-01 Dodge Ram 1500
94-02 Dodge Ram 2500/3500
- LH-007 02-up Dodge Ram 1500
03-up Dodge Ram 2500/3500

\$19.95

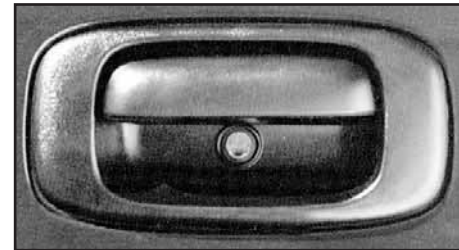

- High Impact Plastic Bezel with the Original Factory Look
- Locks the Handle to Keep Tailgate from Opening

TRUCK BED STEP

New revolutionary Truck Bed allows easy access to the front of the bed and tool boxes. Constructed from heavy duty Power Coated Steel and Anodized Cast Aluminum.

- Power Coated Heavy Duty Integrated Mounting Brackets
- Anodized Cast Aluminum Step
- Installs on both driver and passenger side
- Some application requires a single hole to be drilled for installation
- Supports up to 300 lbs.

\$59.95

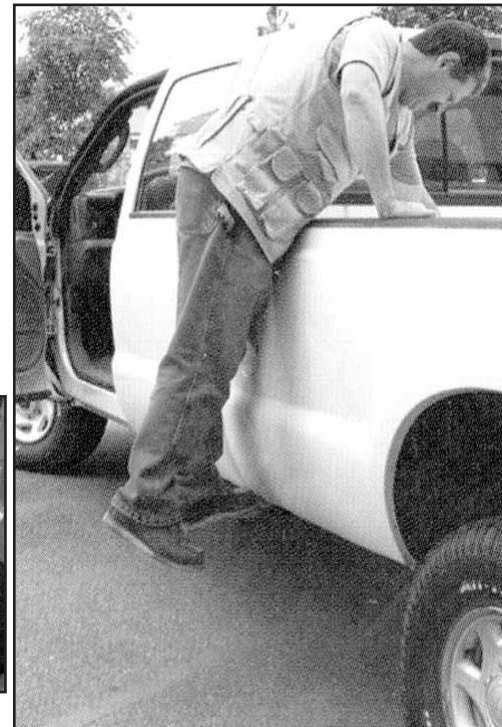

Step plate flips in and out and locks into position.

7643 Fort Laurens Rd. Strasburg, Ohio 44680

www.truckohio.com

HITCH MOUNTED STEP



This hitch mounted utility step allows you to gain easy access to luggage racks, truck beds or SUV interiors. It fits all standard 2" hitch receivers.

The patented CR-600L has a built-in red L.E.D. light strip which acts as an additional brake light.

\$59.95

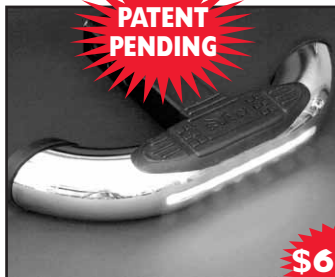

\$69.95

COWBOY TWO STEP



\$44.95

- Convenient hitch mounted step allows you to get up and down from your truck bed easily with your tailgate opened or closed
- Telescopes in and out for easy operation
- Mounts onto most 2" ball mounts with an 8" shaft length



HITCH MOUNTED CARGO RACKS



\$69.95

Cargo Rack

- Mounts on any 2" hitch receiver
- Large available cargo space measuring: 20"x60"
- Black powder coated steel construction
- Provides maximum durability
- Supports a 500 pound load
- Easy installation, no drilling required



\$69.95

Tubular Cargo Rack

- Mounts on any 2" hitch receiver
- Lightweight, tubular design
- Large available cargo space measuring 20"x45"
- Black powder coated steel construction
- Provides maximum durability
- Supports a 500 pound load
- Easy installation, no drilling required

Hitchin' Rod

Finally! Someone has come out with an easy way to hook up a trailer. The hitchin' Rod from Qworks will revolutionize the way you hitch up. Magnets make it easy to attach the rods to the hitch components.

**\$19.95
Pair**

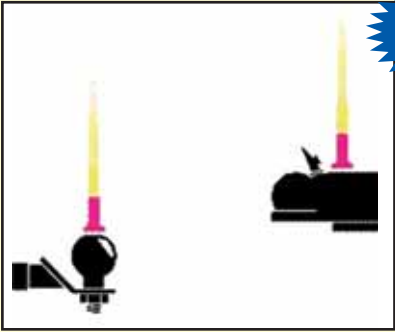

Step 1: Put a Hitchin' Rod on the front-most flat part of your coupler, as well as on the hitch ball.

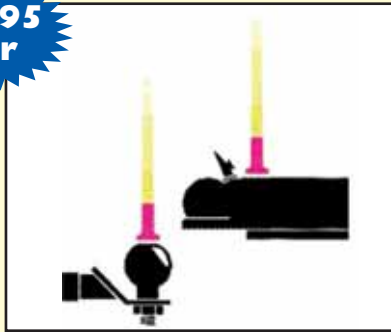

Step 2: Line them up in your rear view mirror.

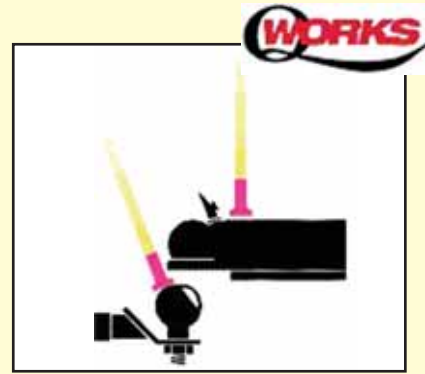

Step 3: As soon as the rod on the ball moves, you're ready to go!

EDGE PRODUCTS

ATTITUDE

JUICE

If you own a diesel-powered vehicle, Edge makes a product that vastly improves the way your truck or RV performs. That may sound like a bold statement, but we have the dyno results and the satisfied customers to prove it! Edge products are designed to maximize your vehicle's performance for the type of driving you do. Whether you want power to tow, power to go, or a simple increase in fuel efficiency, edge products will improve the capabilities and enjoyment of your diesel-powered vehicle.



**Installation
Available**

Prices vary by vehicle. Call for pricing.

Bed Rails

- High Polished Stainless Steel
- No Drilling - Easy Installation
- 1 7/8" Stainless Steel with Mandrel Bends
- Attractive Styling



7643 Fort Laurens Rd. Strasburg, Ohio 44680

Front End Replacement



RANCH HAND
TRUCK ACCESSORIES

Fender Flares

The front end replacement is a legendary product that provides the maximum protection for your vehicle. The front end replacement is designed to take an impact both on and off the road. This is the toughest product on the market and has been field tested in extreme conditions.

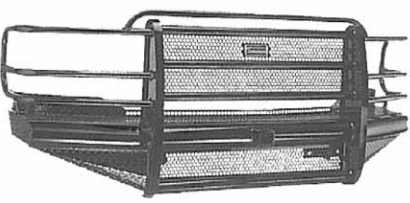

Protection with Style!

- Ideal for factory or wider wheels
- Easy no drill installation
- Designed to withstand tough treatment
- Available for popular vehicles
- Easily painted to match paint color
- Also works great for covering rusty fenderwells



fia Custom Fit Truck Seat Cover

OE series is available in Taupe/Mocha, Light Gray/Dark Gray, and Charcoal/Black



Fia has a lot of applications for most pick-ups, minivans, and SUV's. All are quick and easy to install with Super-Grip, the slip resistant fastening system using belt and buckle fasteners, zippers and velcro.

Each Fia seat cover features:

- Foam padded back support for added comfort
- Washable, lightfast, colorfast, and flame resistant fabric that is warm in winter and cool in summer



Wrangler™ saddle blanket material also available in brown, navy and wine

Deflect-a-Shield Premium Bed Protection

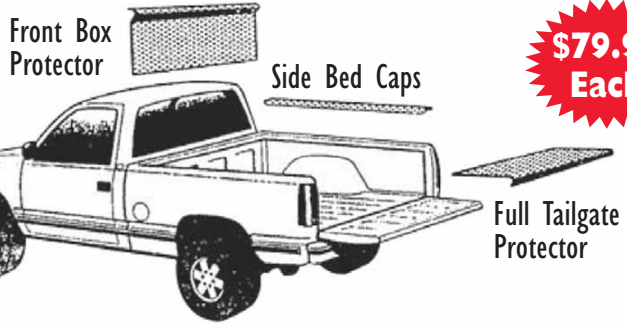

\$79.95 Each

EGR Bed Rail Caps

Bed Rail Caps \$69.95
Tailgate Caps \$19.95

- Here are a few of the pros of getting EGR bed rail caps.
- Custom fit for your vehicle
 - UV stable material
 - Textured material to reduce scratching
 - No drill mounting system and easy installation.



Available with or without stake hole cutouts

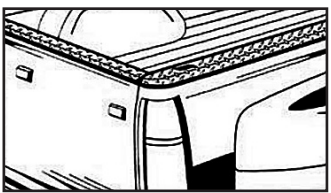

- Full wrap-around coverage offers the best in bed protection
- Offers a clean, seamless appearance when used with Diamond Brite tailgate Protector

EGR SuperGuard

\$59.95



Protect your hood and windshield from the bugs and stones. Each piece is computer designed and custom molded to fit your vehicle specifically. Its Smoke Impact 2000 material not only looks great-its also durable. Each shield is designed to allow adequate clearance between the hood and the shield for easy cleaning. Every model comes with a LIFETIME LIMITED WARRANTY.

Installation Bays



Quality Installation Available!

Replacement Gas Tanks



Jeep CJ
Chevy/GMC Pickups
Blazers Suburbans
Ford Pickup Broncos



TRUXEDO
Lo-Profile
 by Shur-Co. Patented

Introducing a low profile, soft roll-up tonneau cover from the makers of The Original TruXedo® tonneau cover



Velcro brand loop measures a full 1.5 inches wide for superior fastening



Angled Rails provide a sleek look, and allow the cover to sit less than 1 inch above the bed.



Includes a patented fastening system, automatic tension control and corner seating.



HUSKY LINERS

Custom Molded Mud Guards... The Next Step™

Floor Liners

- Protection Prevents stains and soiling of your carpeted areas, therefor increases your vehicle resale value.
- Touch & Durable patented rubberized material is resistant to most chemicals, including gasoline, oil and battery acid.
- Installs Easily in seconds without screws, bolts of fasteners.
- Customer Fit designed to specifically fit your vehicle



Mud Guards

- Lifetime Guarantee
- Tough Protection
- Custom Contoured



MANY STYLES TO CHOOSE FROM

\$64.95



\$29.95 Pair

CALL FOR DETAILS

- Chromed Aluminum Beautiful shine without the Rust
- Available in chrome or polished Aluminum



7643 Fort Laurens Rd. Strasburg, Ohio 44680

Dually Accessories

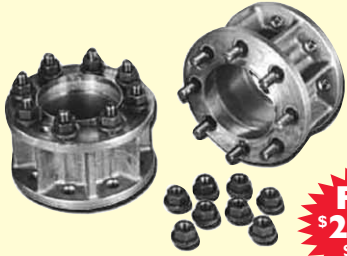

**From
\$295 to
\$325**

AA-4

The AA-4 series of Front Adaptors are designed for the same bolt pattern as the Magnum series. They allow you to use the same dual style wheels on the front axle, giving your truck A complete dually look. AA-4's accommodate both 2 and 4 wheel drive trucks.



**Starting
at
\$65 ea.**

Dually Wheels



**From
\$375 to
\$425**

Magnum

Have you ever wanted to turn your 3/4 ton 8 lug or 1 ton single wheel pickup or Suburban into a dually? Now it's as easy as changing a tire. By using our precision Machined solid steel adaptors. You get the benefits of a dually without the high cost.

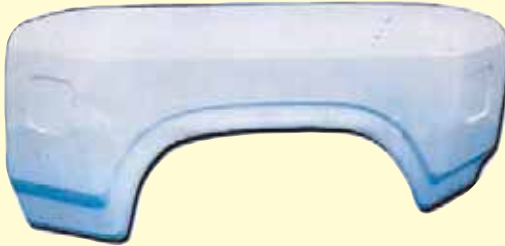

Dually Fenders

Arrowcrafts dually fenders are specially designed to match the contours of your truck. They are easy to install and paint. They give you a factory dually look without the high cost of factory prices!



**\$129.95
Includes
Tailgate
Protectors**



Rugged Protection

Each Rugged Liner Bedliner is custom-designed for a factory perfect fit in domestic and import pickups.

Tough and durable, the Rugged Liner Bedliner helps to prevent costly cargo box and tailgate repairs. Molded from a single sheet of polyethylene. Ribbed construction prevents water pooling. Air flow design helps to eliminate trapped moisture. Even with tough use, the rugged Liner Bedliner proves virtually dent and chip proof to keep vehicle looking newer, longer. The proven design feature tough patented front corners. In addition to protection from physical damage, the Rugged Liner Bedliner is impervious to most acids, fuels, fertilizers and salts, and resists damage from exposure to UV rays.



**Custom
Fit Heavy
Duty
Bedmats
\$59.95**

**Tailgate
Mats
\$24.95**

Installation is quick and easy. No drilling is required. The rugged Liner Bedliner is design to utilize prefabricated attachment points from the manufacturer. Each Rugged Liner Bedliner is backed by a Limited Lifetime Warranty against defects in materials and workmanship.

LICENSED STEERING WHEEL COVERS



From
\$24.95
to
\$29.95





Patriot Lid

Patriot Standard Features

- Hardware Mounting Plates
- NO DRILL Installation
- Painted Base Trim
- Automatic Basecoat/Clear Coat Exterior
- Full Honeycomb Reinforced Roof
- Heavy Duty Gas Props with Lift Assists
- DUAL 2 Stage Rotary Latches-Rod Operated
- Bulb Seal and Protective Edge Trim
- Full Width Front Hinge
- 4 Adjustable Support Legs
- Automotive Grade Locking



The more you compare the Patriot to the competition, the more you will appreciate the extras that SWISS designed into this cover. There's none like it. Compliment your truck with a Patriot.



Fiberglass Truck Covers



Fiberglass Truck Covers Standard Features

- Automotive Basecoat
- Clear Coat Exterior Finish
- Bright White Interior
- Interior Dome Light
- Tinted, Tempered Safety Glass
- Black Trim Windows and Doors
- Radius Side Sliders with Screens
- Radius door with Gas Props
- Honeycomb Reinforced Insulated Roof
- Third Brake Light
- Protective Black Base Trim

Popular Options

- Radius Front Sliding Window
- Dark Tinted Glass
- Special Window Packages
- Slide Access Windows
- Clothes Rack
- Painted Base Trim
- Sport Rack
- Carpeted Headliner



visit www.truckohio.com today!



7643 Fort Laurens Rd. Strasburg, Ohio 44680

www.truckohio.com



HDU Cover



Shown in 23" 29" wedge style, double door with built up rack.



Shown with optional radius rear window



Shown with optional double side doors, French doors and rear mitered windows.



Shown with option French doors and radius rear windows.



HDU Standard Features

- Heavy Duty .080 Mounting Rails
- Deluxe "H" Ladder Rack with Center Bar
- 5 Bow Construction
- Black Trim with Finished Base Edge
- 3 Point Latching System on Side Doors with Black Fold-Down "T" Handles
- Smooth .030 Exterior Skin
- Weather Sealed Doors
- 2 Post Corner Frame Construction
- Choice of 7 Standard Colors
- Half-Gate Lift up Rear Doors Solid Panel

You can choose from a wide variety of options to customize your HDU, and meet your specific needs.

- Door and Window Configuration
- Cap Height
- Ladder Rack Designs
- Interior Dome Light
- Toolbox and Shelving Designs
- Roof Styles
- Keyless Entry

Interior Height Units

- 23" Straight Roof
- 29" Straight Roof
- 35" Straight Roof
- 23" 29" Wedge Design

In addition to the standard colors, Swiss paints HDU's using the automotive basecoat, clearcoat process, match to your truck's color code.

7643 Fort Laurens Rd. Strasburg, Ohio 44680



7643 Fort Laurens Road
Strasburg, Ohio 44680

Presorted Std
US Postage
PAID
MAILER'S CHOICE